

# MJD2955 (PNP) MJD3055 (NPN)

## Complementary Power Transistors

### DPAK For Surface Mount Applications

Designed for general purpose amplifier and low speed switching applications.

#### Features

- Lead Formed for Surface Mount Applications in Plastic Sleeves (No Suffix)
- Straight Lead Version in Plastic Sleeves (“-1” Suffix)
- Electrically Similar to MJE2955 and MJE3055
- DC Current Gain Specified to 10 Amperes
- High Current Gain–Bandwidth Product –  $f_T = 2.0$  MHz (Min) @  $I_C = 500$  mAdc
- Epoxy Meets UL 94 V-0 @ 0.125 in
- ESD Ratings: Human Body Model, 3B > 8000 V  
Machine Model, C > 400 V
- Pb–Free Packages are Available

#### MAXIMUM RATINGS

Rating	Symbol	Max	Unit
Collector–Emitter Voltage	$V_{CEO}$	60	Vdc
Collector–Base Voltage	$V_{CB}$	70	Vdc
Emitter–Base Voltage	$V_{EB}$	5	Vdc
Collector Current	$I_C$	10	Adc
Base Current	$I_B$	6	Adc
Total Power Dissipation @ $T_C = 25^\circ\text{C}$ Derate above $25^\circ\text{C}$	$P_{D\dagger}$	20 0.16	W W/ $^\circ\text{C}$
Total Power Dissipation (Note1) @ $T_A = 25^\circ\text{C}$ Derate above $25^\circ\text{C}$	$P_D$	1.75 0.014	W W/ $^\circ\text{C}$
Operating and Storage Junction Temperature Range	$T_J, T_{stg}$	-55 to +150	$^\circ\text{C}$

#### THERMAL CHARACTERISTICS

Characteristic	Symbol	Max	Unit
Thermal Resistance, Junction–to–Case	$R_{\theta JC}$	6.25	$^\circ\text{C}/\text{W}$
Thermal Resistance, Junction–to–Ambient (Note1)	$R_{\theta JA}$	71.4	$^\circ\text{C}/\text{W}$

Maximum ratings are those values beyond which device damage can occur. Maximum ratings applied to the device are individual stress limit values (not normal operating conditions) and are not valid simultaneously. If these limits are exceeded, device functional operation is not implied, damage may occur and reliability may be affected.

†Safe Area Curves are indicated by Figure 1. Both limits are applicable and must be observed.

1. These ratings are applicable when surface mounted on the minimum pad sizes recommended.



ON Semiconductor®

<http://onsemi.com>

## SILICON POWER TRANSISTORS 10 AMPERES 60 VOLTS, 20 WATTS

#### MARKING DIAGRAMS

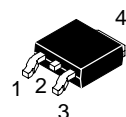

DPAK  
CASE 369C  
STYLE 1

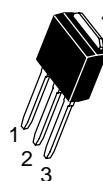
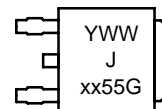

DPAK-3  
CASE 369D  
STYLE 1

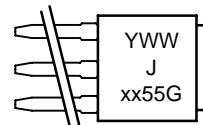

Y = Year  
WW = Work Week  
Jxx55 = Device Code  
x = 29 or 30  
G = Pb–Free Package

#### ORDERING INFORMATION

See detailed ordering and shipping information in the package dimensions section on page 2 of this data sheet.

# MJD2955 (PNP) MJD3055 (NPN)

## ELECTRICAL CHARACTERISTICS (T<sub>C</sub> = 25°C unless otherwise noted)

Characteristic	Symbol	Min	Max	Unit
<b>OFF CHARACTERISTICS</b>				
Collector–Emitter Sustaining Voltage (Note 2) (I <sub>C</sub> = 30 mAdc, I <sub>B</sub> = 0)	V <sub>CEO(sus)</sub>	60	–	Vdc
Collector Cutoff Current (V <sub>CE</sub> = 30 Vdc, I <sub>B</sub> = 0)	I <sub>CEO</sub>	–	50	μAdc
Collector Cutoff Current (V <sub>CE</sub> = 70 Vdc, V <sub>EB(off)</sub> = 1.5 Vdc) (V <sub>CE</sub> = 70 Vdc, V <sub>EB(off)</sub> = 1.5 Vdc, T <sub>C</sub> = 150°C)	I <sub>CEX</sub>	– –	0.02 2	mAdc
Collector Cutoff Current (V <sub>CB</sub> = 70 Vdc, I <sub>E</sub> = 0) (V <sub>CB</sub> = 70 Vdc, I <sub>E</sub> = 0, T <sub>C</sub> = 150°C)	I <sub>CBO</sub>	– –	0.02 2	mAdc
Emitter Cutoff Current (V <sub>BE</sub> = 5 Vdc, I <sub>C</sub> = 0)	I <sub>EBO</sub>	–	0.5	mAdc
<b>ON CHARACTERISTICS</b>				
DC Current Gain (Note 2) (I <sub>C</sub> = 4 Adc, V <sub>CE</sub> = 4 Vdc) (I <sub>C</sub> = 10 Adc, V <sub>CE</sub> = 4 Vdc)	h <sub>FE</sub>	20 5	100 –	–
Collector–Emitter Saturation Voltage (Note 2) (I <sub>C</sub> = 4 Adc, I <sub>B</sub> = 0.4 Adc) (I <sub>C</sub> = 10 Adc, I <sub>B</sub> = 3.3 Adc)	V <sub>CE(sat)</sub>	– –	1.1 8	Vdc
Base–Emitter On Voltage (Note 2) (I <sub>C</sub> = 4 Adc, V <sub>CE</sub> = 4 Vdc)	V <sub>BE(on)</sub>	–	1.8	Vdc
<b>DYNAMIC CHARACTERISTICS</b>				
Current–Gain – Bandwidth Product (I <sub>C</sub> = 500 mAdc, V <sub>CE</sub> = 10 Vdc, f = 500 kHz)	f <sub>T</sub>	2	–	MHz

2. Pulse Test: Pulse Width ≤ 300 μs, Duty Cycle ≤ 2%.

## ORDERING INFORMATION

Device	Package Type	Package	Shipping†
MJD2955	DPAK	369C	75 Units / Rail
MJD2955G	DPAK (Pb–Free)		
MJD2955–001	DPAK–3	369D	
MJD2955–001G	DPAK (Pb–Free)		
MJD2955T4	DPAK	369C	2500 Tape & Reel
MJD2955T4G	DPAK (Pb–Free)		
MJD3055	DPAK		75 Units / Rail
MJD3055G	DPAK (Pb–Free)		
MJD3055T4	DPAK		2500 Tape & Reel
MJD3055T4G	DPAK (Pb–Free)		

†For information on tape and reel specifications, including part orientation and tape sizes, please refer to our Tape and Reel Packaging Specifications Brochure, BRD8011/D.

# MJD2955 (PNP) MJD3055 (NPN)

## TYPICAL CHARACTERISTICS

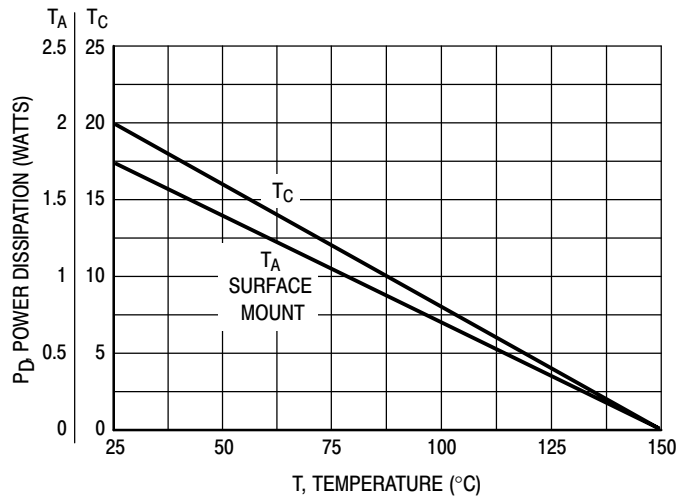

Figure 1. Power Derating

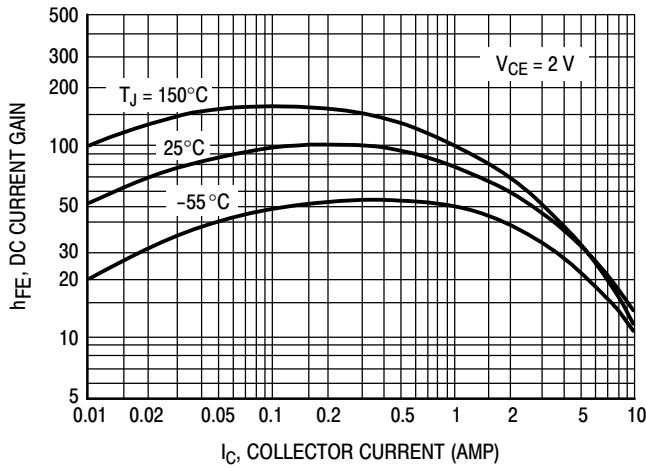

Figure 2. DC Current Gain

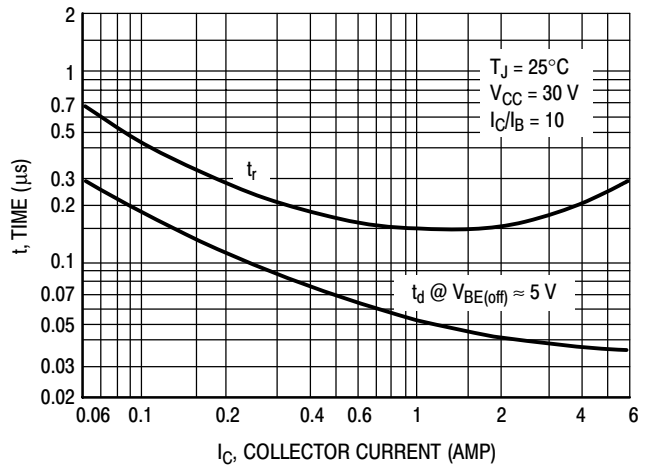

Figure 3. Turn-On Time

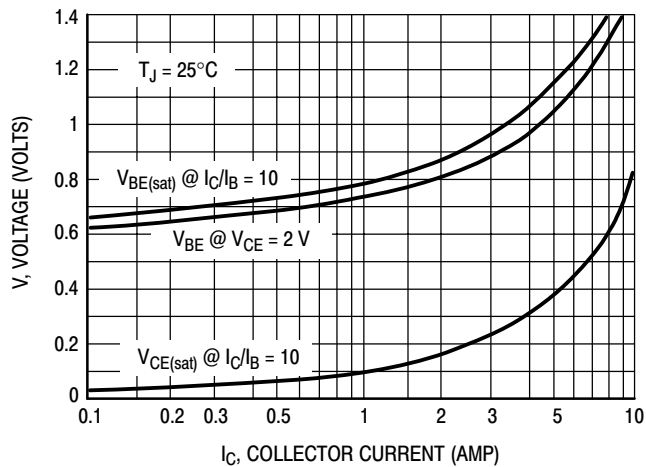

Figure 4. "On" Voltages, MJD3055

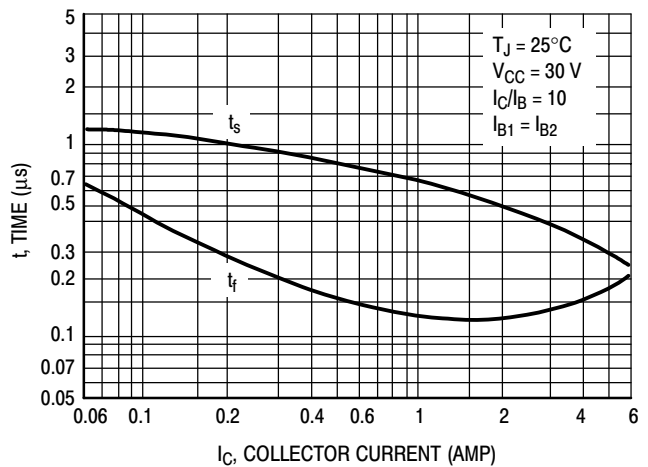

Figure 5. Turn-Off Time

# MJD2955 (PNP) MJD3055 (NPN)

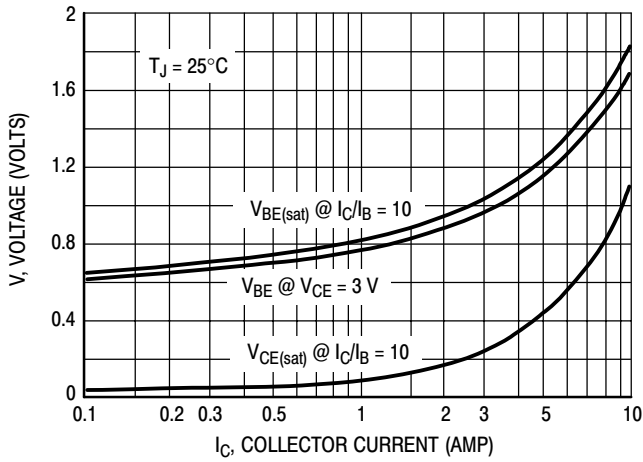

Figure 6. "On" Voltages, MJD2955

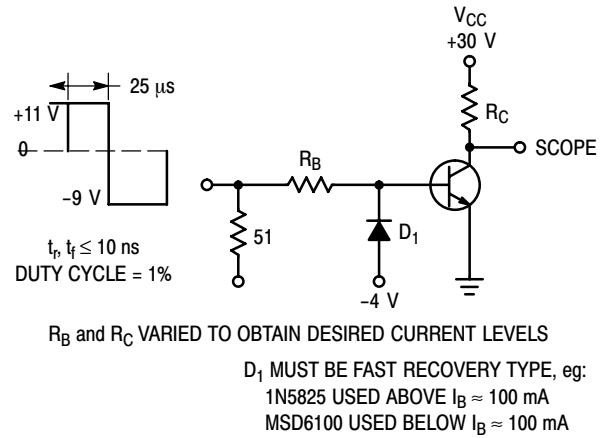

Figure 7. Switching Time Test Circuit

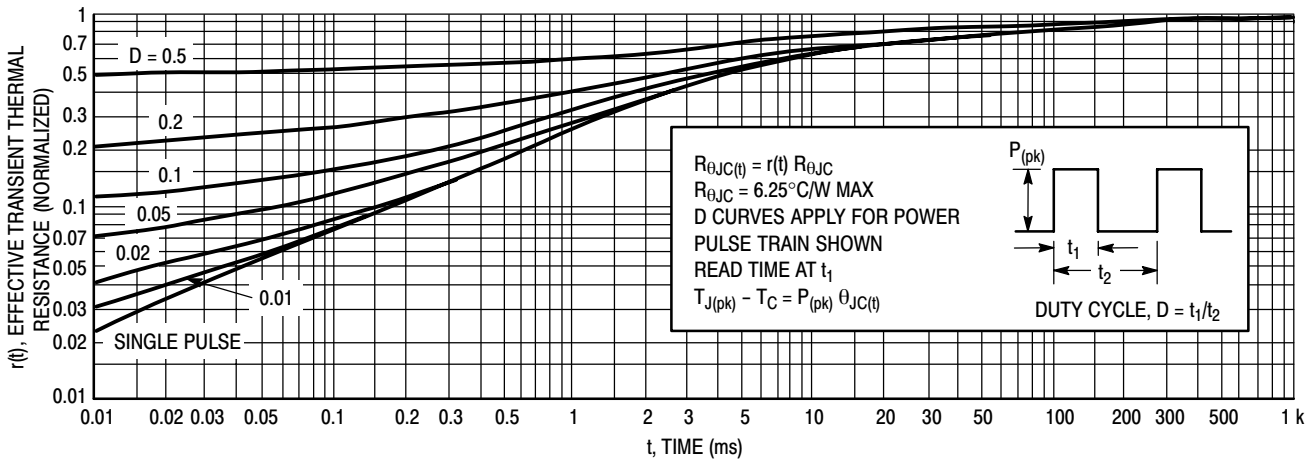

Figure 8. Thermal Response

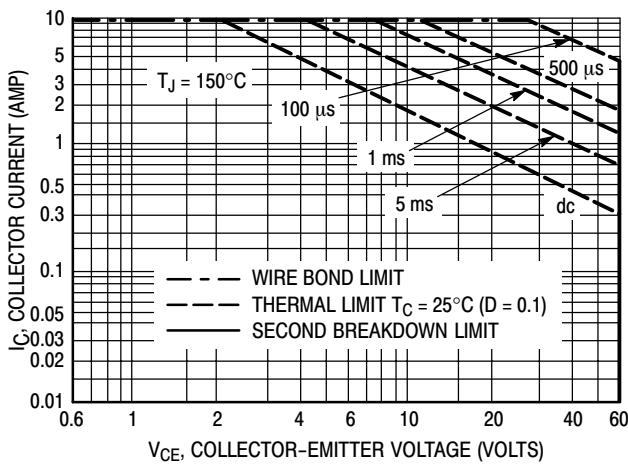

Figure 9. Maximum Forward Bias Safe Operating Area

## FORWARD BIAS SAFE OPERATING AREA INFORMATION

There are two limitations on the power handling ability of a transistor: average junction temperature and second breakdown. Safe operating area curves indicate  $I_C - V_{CE}$  limits of the transistor that must be observed for reliable operation; i.e., the transistor must not be subjected to greater dissipation than the curves indicate.

The data of Figure 9 is based on  $T_{J(pk)} = 150^\circ\text{C}$ ;  $T_C$  is variable depending on conditions. Second breakdown pulse limits are valid for duty cycles to 10% provided  $T_{J(pk)} \leq 150^\circ\text{C}$ .  $T_{J(pk)}$  may be calculated from the data in Figure 8. At high case temperatures, thermal limitations will reduce the power that can be handled to values less than the limitations imposed by second breakdown.

# MJD2955 (PNP) MJD3055 (NPN)

## PACKAGE DIMENSIONS

**DPAK**  
CASE 369C-01  
ISSUE O

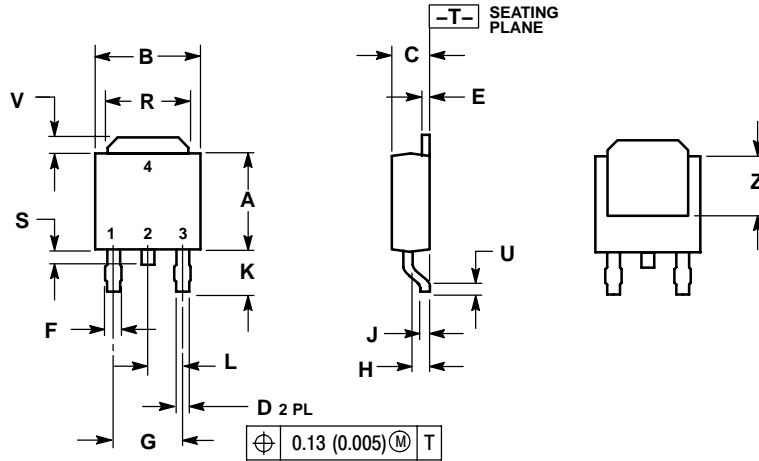

- NOTES:  
1. DIMENSIONING AND TOLERANCING PER ANSI Y14.5M, 1982.  
2. CONTROLLING DIMENSION: INCH.

DIM	INCHES		MILLIMETERS	
	MIN	MAX	MIN	MAX
A	0.235	0.245	5.97	6.22
B	0.250	0.265	6.35	6.73
C	0.086	0.094	2.19	2.38
D	0.027	0.035	0.69	0.88
E	0.018	0.023	0.46	0.58
F	0.037	0.045	0.94	1.14
G	0.180 BSC		4.58 BSC	
H	0.034	0.040	0.87	1.01
J	0.018	0.023	0.46	0.58
K	0.102	0.114	2.60	2.89
L	0.090 BSC		2.29 BSC	
R	0.180	0.215	4.57	5.45
S	0.025	0.040	0.63	1.01
U	0.020	---	0.51	---
V	0.035	0.050	0.89	1.27
Z	0.155	---	3.93	---

- STYLE 1:  
PIN 1. BASE  
2. COLLECTOR  
3. EMITTER  
4. COLLECTOR

### SOLDERING FOOTPRINT\*

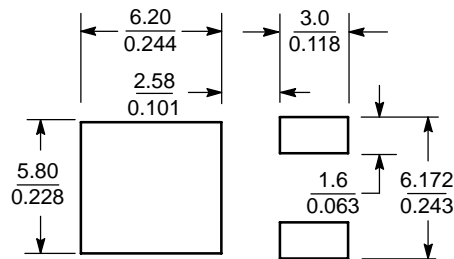

SCALE 3:1  $\left(\frac{\text{mm}}{\text{inches}}\right)$

\*For additional information on our Pb-Free strategy and soldering details, please download the ON Semiconductor Soldering and Mounting Techniques Reference Manual, SOLDERRM/D.

# MJD2955 (PNP) MJD3055 (NPN)

## PACKAGE DIMENSIONS

DKPAK-3  
CASE 369D-01  
ISSUE B

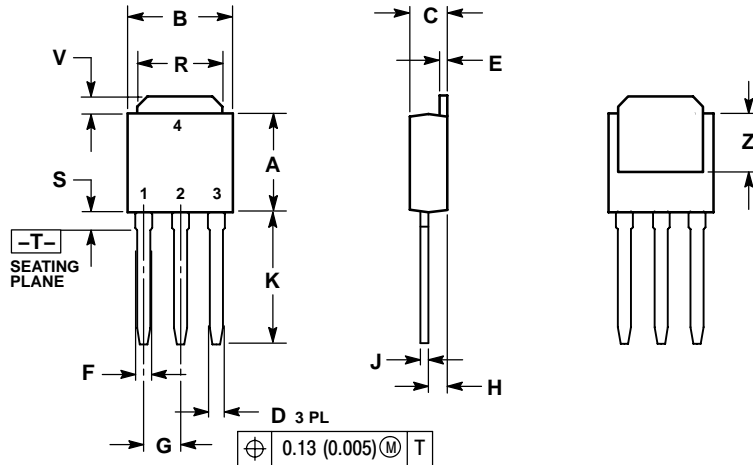

NOTES:

1. DIMENSIONING AND TOLERANCING PER ANSI Y14.5M, 1982.
2. CONTROLLING DIMENSION: INCH.

DIM	INCHES		MILLIMETERS	
	MIN	MAX	MIN	MAX
A	0.235	0.245	5.97	6.35
B	0.250	0.265	6.35	6.73
C	0.086	0.094	2.19	2.38
D	0.027	0.035	0.69	0.88
E	0.018	0.023	0.46	0.58
F	0.037	0.045	0.94	1.14
G	0.090 BSC		2.29 BSC	
H	0.034	0.040	0.87	1.01
J	0.018	0.023	0.46	0.58
K	0.350	0.380	8.89	9.65
R	0.180	0.215	4.45	5.45
S	0.025	0.040	0.63	1.01
V	0.035	0.050	0.89	1.27
Z	0.155	---	3.93	---

STYLE 1:

- PIN 1. BASE
2. COLLECTOR
3. EMITTER
4. COLLECTOR

ON Semiconductor and are registered trademarks of Semiconductor Components Industries, LLC (SCILLC). SCILLC reserves the right to make changes without further notice to any products herein. SCILLC makes no warranty, representation or guarantee regarding the suitability of its products for any particular purpose, nor does SCILLC assume any liability arising out of the application or use of any product or circuit, and specifically disclaims any and all liability, including without limitation special, consequential or incidental damages. "Typical" parameters which may be provided in SCILLC data sheets and/or specifications can and do vary in different applications and actual performance may vary over time. All operating parameters, including "Typicals" must be validated for each customer application by customer's technical experts. SCILLC does not convey any license under its patent rights nor the rights of others. SCILLC products are not designed, intended, or authorized for use as components in systems intended for surgical implant into the body, or other applications intended to support or sustain life, or for any other application in which the failure of the SCILLC product could create a situation where personal injury or death may occur. Should Buyer purchase or use SCILLC products for any such unintended or unauthorized application, Buyer shall indemnify and hold SCILLC and its officers, employees, subsidiaries, affiliates, and distributors harmless against all claims, costs, damages, and expenses, and reasonable attorney fees arising out of, directly or indirectly, any claim of personal injury or death associated with such unintended or unauthorized use, even if such claim alleges that SCILLC was negligent regarding the design or manufacture of the part. SCILLC is an Equal Opportunity/Affirmative Action Employer. This literature is subject to all applicable copyright laws and is not for resale in any manner.

### PUBLICATION ORDERING INFORMATION

**LITERATURE FULFILLMENT:**  
Literature Distribution Center for ON Semiconductor  
P.O. Box 61312, Phoenix, Arizona 85082-1312 USA  
**Phone:** 480-829-7710 or 800-344-3860 Toll Free USA/Canada  
**Fax:** 480-829-7709 or 800-344-3867 Toll Free USA/Canada  
**Email:** orderlit@onsemi.com

**N. American Technical Support:** 800-282-9855 Toll Free  
USA/Canada

**Japan:** ON Semiconductor, Japan Customer Focus Center  
2-9-1 Kamimeguro, Meguro-ku, Tokyo, Japan 153-0051  
**Phone:** 81-3-5773-3850

**ON Semiconductor Website:** <http://onsemi.com>

**Order Literature:** <http://www.onsemi.com/litorder>

For additional information, please contact your local Sales Representative.